







36 425 977



- cover plate Ø 175 mm
- temperature control handle with safety limit stop at 38°C
- hot water temperature limiter, can be preset

	Chrome	36 425 977-00
	Brushed Platinum	36 425 977-06
	Platinum	36 425 977-08
	Durabress (23kt Gold)	36 425 977-09
	Brushed Durabress (23kt Gold)	36 425 977-28
	Brushed Dark Platinum	36 425 977-99

**Required miscellaneous**



**Concealed thermostat with built-in isolators -** 35 426 970 90

- max. recess depth 136 mm
- min. recess depth 80 mm

**Required miscellaneous**



**Concealed thermostat -** 35 425 970 90

- max. recess depth 136 mm
- min. recess depth 80 mm

**Recommended miscellaneous**



**xGRID Attachment set for integrating in the dry wall construction -** 12 340 970 90

**Required miscellaneous**



**xGRID Installation track 555 mm -** 12 360 970 90

36 425 977

mm [inches]

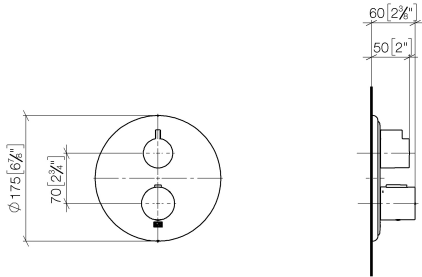

**Flow rate chart**

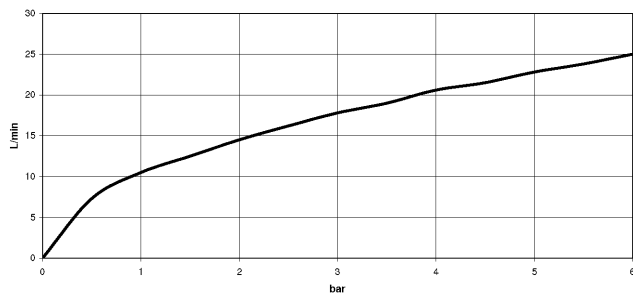

**Certificates**

LGA\_19385.

ETA\_20551.

DVGW\_DW-  
6512DN0119.

LGA\_19384.

WRAS\_1906098.

36 425 977

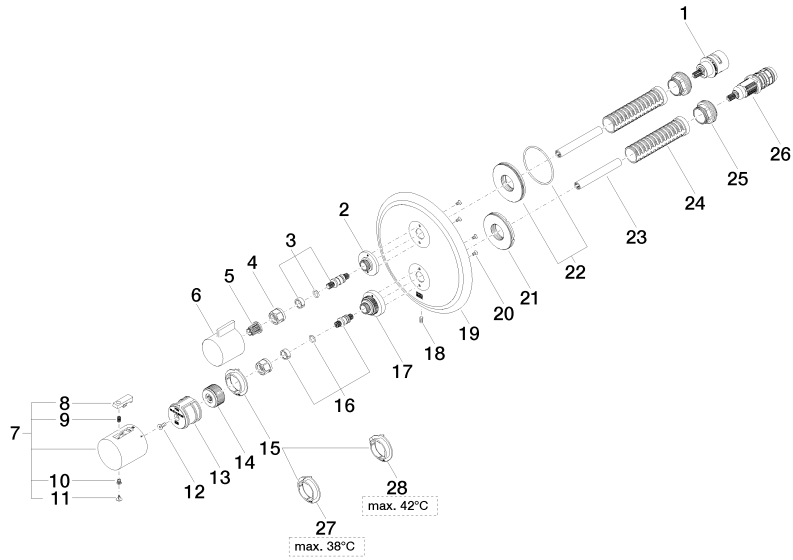

36 425 977

Spare parts list

No.	Item Number	Name	Quantity used	Delivery time
1	90 90 03 166 00 90	top	1	2
2	09 12 12 053-00	base	1	10
3	04 29 06 111 01-00	spindle	1	10
4	90 23 30 023 00 90	nut	2	2
5	90 12 12 002 00 90	fixing cap	1	2
6	09 20 67 006-00	handle	1	10
7	90 17 33 004 00-00	handle	1	10
8	90 21 33 011 00-13	handle	1	2
9	90 16 02 027 00 90	spring	1	2
10	90 30 30 136 00 90	screw	1	2
11	90 31 20 049 00-00	plug	1	10
12	90 30 30 124 00 90	screw	1	2
13	90 12 12 052 00 90	base	1	2
14	09 12 12 054 90	base	1	2
15	09 28 10 187 90	regulator	1	2
16	04 29 06 024 01-00	spindle	1	10
17	09 12 12 051-00	base	1	10
18	09 31 11 134 90	pin	1	2
19	09 11 02 307-00	plate	1	60
20	09 30 30 157 90	screw	4	2
21	09 30 01 296 90	disc	1	2
22	90 30 01 190 00 90	disc	1	2
23	90 23 01 124 00 90	sleeve	2	2
24	90 18 40 077 01 90	spindle	2	2
25	09 24 04 257 90	nut	2	2
26	90 15 02 013 00 90	cartridge	1	2
27	09 28 10 188 90	regulator	1	2
28	09 28 10 189 90	regulator	1	2